

Easy-Loading Thermal Printer

Mulde Mini GPT-4352 GPT-4352-60 with Controller System A8

GeBE®

**GeBE Elektronik und
Feinwerktechnik GmbH**

Modules and devices for input,
analysis, display and printing of
analog and digital data.

GeBE Document No.:
SMAN-E-627-V1.2
Article No.: 13108

Printed: 29.07.2014
Status: 29.07.2014
German: SMAN-D-628



Operating Manual

GeBE Contacts

Printers: GeBE Elektronik und Feinwerktechnik GmbH • E-Mail: sales.ef@gebe.net • www.gebe.net
Keyboards: GeBE Computer & Peripherie GmbH • Email: sales@tastaturen.com • www.tastaturen.com
Internet Applications: www.gebe.net

The GeBE logo is a registered trademark of GeBE Elektronik und Feinwerktechnik GmbH. All other brands named in this brochure are properties of the respective companies. The technical data given are non-committal information and do not represent any assurance of certain features. Errors and changes reserved. This technical documentation is only valid until release of a revision. Please always request the newest documentation edition. Our terms of payment and delivery apply. Copyright © 2014 GeBE Elektronik und Feinwerktechnik GmbH. All rights reserved.

GeBE Elektronik und Feinwerktechnik GmbH
Beethovenstr. 15 • Germering • Germany • www.GeBE.net
Phone: +49 (0) 89/894141-0 • Fax: +49 (0) 89/894141-33 • email: sales.ef@gebe.net

1 Contents

| | | | |
|--|----|---------------------------------|----|
| 2 Safety Instructions | 3 | 8.2 Thermal Paper | 10 |
| 3 Packing List | 4 | 9 Maintenance and Service | 11 |
| 3.1 Options / Accessories | 4 | 9.1 Cleaning | 11 |
| | | 9.2 Service | 11 |
| 4 Options for Installation | 5 | 9.3 Warranty | 11 |
| 4.1 Installation in a Front Panel | 5 | | |
| 4.2 Partial Installation in Plastic Enclosure | 5 | 10 Character Sets | 12 |
| 4.3 Examples for Installation and Applications | 5 | 10.1 Font Sizes | 12 |
| 5 Connecting the Printer | 6 | 11 Status Signals | 13 |
| 5.1 Connecting the Voltage Supply (1) | 6 | | |
| 5.2 Pining GPT4352 seriell | 6 | 12 Troubleshooting and Recovery | 14 |
| 6 Setting up the Printer through Toolbox | 7 | 13 CE Certification | 15 |
| 6.1 Setting up the Printer through Toolbox (PC Software) | 7 | | |
| 6.2 Firmware Download | 7 | 14 Technical Data | 16 |
| 7 Interfaces | | 15 Mechanical Dimensions | 16 |
| 7.1 Serial Interface | 8 | | |
| 7.1.1 Serial Interface RS232 (V.24) at Connector J2 | 8 | | |
| 7.1.2 Timing of the Serial RS232 /TTL Interface | 8 | | |
| 7.2 USB Interface | 9 | | |
| 8 Operation | 10 | | |
| 8.1 Button functions | 10 | | |

2 Safety Instructions



Safe operation of this device is only warranted, if the instructions in this operating manual have been complied with. The appropriate application and use in accordance with the operating instructions is binding for product liability and product warranty. Attempts by the customer to repair the device will make all warranty claims null and void. With technical questions, please contact GeBE Technical Support.

For installation: Always disconnect system power supplies.

Only use manufacturer's parts and accessories. Make sure that the printer is protected against electrical surges in accordance with EN/IEC 60950.

- The device may only be opened or repaired by authorized personnel. Never open the device or carry out repairs yourself. Always contact an authorized technical servicer.

You can find all necessary service information in the chapter "Service and Maintenance".

- Before the device is turned on, make sure that the system voltage of your installation matches the supply voltage of the device. The device characteristics are printed on the name plate and in the technical data.

- The name plate is located on the underside of the device.

- For the technical data refer to chapter 15.

- The peripheral devices that are connected to the interfaces and the DC circuits of this device have to meet the requirements for low safety voltage in accordance with EN/IEC 60950.

- Switching off the device does not completely disconnect it from the power supply. Your device is only disconnected completely, when the power is unplugged.

- Please make sure that the power supply cable is run in such a way that nobody trips over it, and it cannot be damaged by other devices.



- During operation, surfaces in the surrounding area of the print head may heat up. Therefore, direct contact with the print head must be avoided to prevent burning accidents. Do not put heat sensitive objects close to this heat source.

- Avoid constant high humidity and condensation. Protect the device from being splashed and from coming in contact with chemicals.

- Only use spare parts and accessories supplied or authorized by GeBE. The use of unauthorized parts or accessories may considerably affect the function and safety of the device. All parts included are listed in the chapter "Packing List", while the original accessories are listed in the chapter "Parts and Accessories".



- It is no longer possible to safely operate the device, if:

- the housing has been damaged due to mechanical overload
- moisture reached the inside of the device
- smoke is coming from the inside of the device
- the power supply cord is damaged
- the device stopped working properly

- It is prohibited to operate the device, if the housing is damaged.

Unplug or turn off the device immediately, when such a failure occurs, and contact your customer service. See chapter "Service and Maintenance".

- We expressly point out that the appropriate application and use in accordance with the operating instructions in this manual and on the device itself is binding for product liability and product warranty.

3 Packing List

| Artikel No. | Printer description | Interfaces | | Features | | |
|-------------|-----------------------------------|-------------|-----|--------------------|-------------------------|--|
| | | RS232, V.24 | USB | Z/Zeile: 24 und 48 | Farbe Anthrazit RAL7016 | |
| 12986 | GPT-4352-LV-92-24-USB-at | | X | X | X | |
| 12622 | GPT-4352-LV-92-24-V.24-at | X | | X | X | |
| 12985 | GPT-4352-60-LV-92-24-USB-at | | X | X | X | |
| 12480 | GPT-4352-60-LV-92-24-V.24-at | X | | X | X | |
| 13080 | GPT-4352-60-LV-93-24-V.24-DC24-at | X | | X | X | |
| 13083 | GPT-4352-60-LV-93-24-USB-DC24-at | | X | X | X | |

All Easyload Thermal Printers GPT-4352/ GPT-4352-60 starter sets contain:

- Thermal paper, 5 rolls:
GPR-T01-058-031-007-060A resp.
GPR-T01-058-060-007-060A for
GPT4352-60
- Operating manual: SMAN-E-627



Please check during the unpacking process that all parts have been delivered completely and undamaged. Make sure to remove all parts from the packaging material. Claims for damages caused during transport can only be asserted, if the carrier is informed without delay. Please prepare a survey report and send it back to the supplier along with the damaged part.

3.1 Options / Accessories

Installation Aids GPT-4352

- GMS-4352-3HE-18TE 3HE 3U front panel for 19" racks ,18U width (Art. 11415)
- GMS-4352-96x96 front panel for DIN housings (Art. 11414)

Installation Aids GPT-4352-60

- GMS-4352-60-3HE-18TE 3U front panel for 19" racks ,18U width (Art. 12610)

Paper

- GPR-T01-057-031-007-060A standard 5 years (Art. 11347)
- GPR-T151-057-031-007-120A unending paper (Art. 12428)
- GPR-T151-057-031-012-120A 52x51labels (Art. 12698)
- GPR-T101-057-031-007-060A standard 10 years (Art. 12032)
- GPR-T251-057-031-007-060A standard 25 years (Art. 12033)

- GPR-T01-057-060-007-060A standard 5 years (Art. 12410)
- GPR-T152-057-060-025-120A 52x51labels (Art. 13422)
- GPR-T151-057-060-025-120A unending paper (Art. 12984)
- GPR-T101-057-060-012-060A standard 10 years (Art. 12982)
- GPR-T251-057-060-012-060A standard 25 years (Art. 12983)

Connection cable

- GKA-410-1-250 Power supply cable ST (7pin) 250 mm, open ended (Art. 11353)
- GKA-414-1-500 Serial cable RS232/TTL (Art. 11387)
- GKA-406-2-1000 Round cable RS232 Sub-D socket 9pin. 1.0 m (Art. 11352)
- GKA-570-2-2000 USB cable 2.0 m (Art. 12872)

Power supply/Power cable

- **GNG-6VDC-2,5VA** Wall power supply for direct voltage supply (Art. 12290)
- GKA-430-2-250 Power supply cable chargin socket/con (Art. 11447)
- **GNG-5V-5A-AC** Power supply open frame (Art. 10473)
- GKA-352-2-1500 Power cable 3p. 1,5 m (Art. 11002)
- GKA-410-1-250 Power supply cable one end open 7p. 250 mm (Art. 11353)
- **GNG-6,5V-3A-(10-36)VDC** DC/DC converter input (10-36) VDC output 6.5 VDC (Art. 11451)
- GKA-284-1-500 Power supply cable 2p. 0,5 m wire end sleeve (Art. 10414)
- GKA-435-2-110 Cable connection converter/con 7p. 110 mm (Art. 11466)
- **GNG-6,5V-3A-(10-36)VDC** DC/DC converter input (10-36) VDC output 6.5 VDC mounted (Art. 12618)
- GKA-284-1-500 Power supply cable 2p. 0.5 m wire end sleeve (Art. 10414)
- GKA-409-1-190 Power supply cable DC 24, one side open ended (Art. 11362)

4 Options for Installation

4.1 Installation in a Front Panel

The printer GPT-4352 in its plastic housing can be easily installed with only two screws in a simply created cutout of a front panel with up to 4 mm thickness. The contact surface is plane. The plastic housing has a 1 mm wide flange on all four sides covering the small gap between front panel surface and plastic housing.

The plastic housing is pushed into the cutout **from the outside**, where it is then screwed tight to two tabs.

The two drill holes have a diameter of 2.8 mm, allowing the use of M2.5 screws.

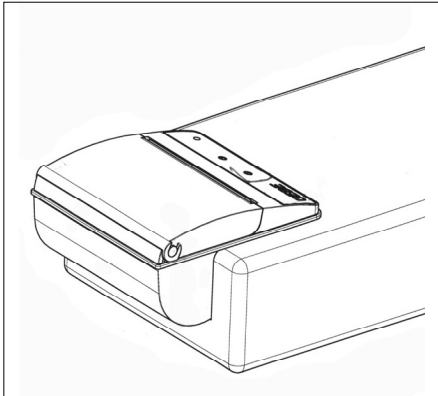

4.2 Partial Installation in Plastic Enclosure

As shown in the drawing on the left, the printer housing can also be installed in the flange of an enclosure. This version has the part of the plastic housing containing the paper roll protrude from the enclosure, leaving more space inside the enclosure for the installation of other components.

In order to facilitate the installation in various shapes of enclosures, the exterior wall of the paper storage was left flat underneath the contact flange. About half of the paper storage compartment up to the tilted slot for the insertion of the mounting link can be used, so the plastic housing may extend beyond the enclosure by up to about 19 mm.



4.3 Examples for Installation and Applications

As these images show, this printer has an almost unlimited array of installation options.

The advantage of the compact thermal printer module is that it allows the convenient Easyload Technology to be used for applications with smaller production quantities.

GeBE also offers the matching paper rewriter module for the printer module. As illustrated above, a printer with a presenter port can be placed in a DIN switchboard housing.

The plastic housing is also used in the miniature printer series POCKET from GeBE.

It is ideal for handheld computer with an attached print station.

5 Connecting the Printer



During installation:
Always disconnect the power!

Avoid reverse polarity of connections, which would cause immediate damage to the printer. Carefully check the power supply connection after the wiring is completed before you turn on the power.

5.1 Connecting the Voltage Supply (1)

The printer can be operated with fixed voltage from a power supply unit. Through the voltage supply connection, the printer can be supplied with voltages between 4.5 V and 7.2 V. The matching logic voltage is generated on the circuit board. The included power supply cable GKA-410 connects to connector J4 (3 red wires for +4.5 to 7.2 VDC, 3 black wires for ground, and a white wire for an NTC 6.8 kOhm of a Ni-MH battery). In simple power connections, the white cable remains without a function. It is recommended to keep the length of the cable as short as possible. If the cable is too long, the high wire resistance will result in a bad print image, or can even cause damage to the printer.

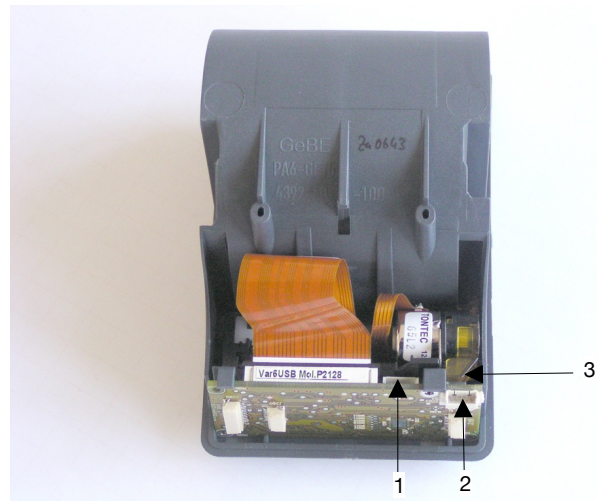

Labeling:

- 1 Connection voltage supply
- 2 Connection USB
- 3 Connection serial

5.2 Pining GPT-4352 seriell

a) Power supply:

| Pin | description |
|-----|---------------|
| 1 | GND |
| 2 | GND |
| 3 | GND |
| 4 | Vcc (10-36 V) |
| 5 | Vcc |
| 6 | Vcc |

b) Serial connection:

| Pin | description |
|-----|-------------|
| 1 | GND |
| 2 | RxD input |
| 3 | TxD output |
| 4 | CTS input |
| 5 | RTS output |

c) Molex-plug USB:

| Pin | description |
|-----|-------------|
| 1 | USB-Vcc |
| 2 | GND |
| 3 | USB-D - |
| 4 | USB-D + |
| 5 | GND |

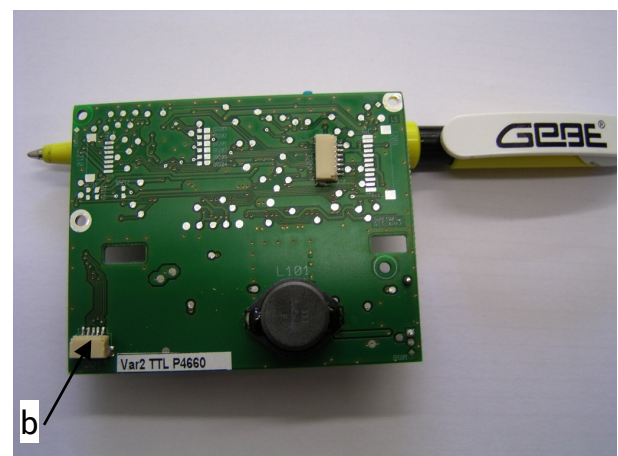
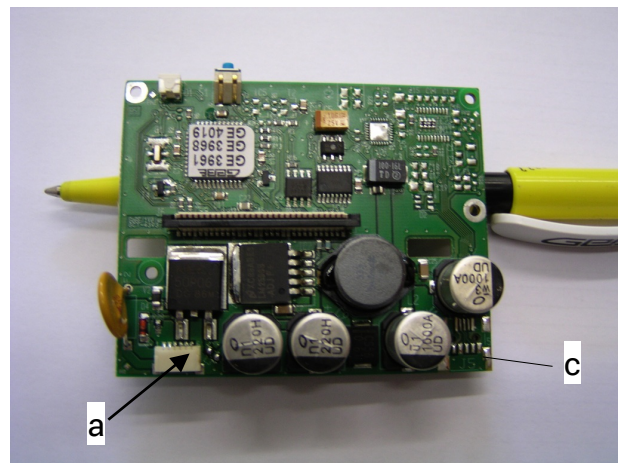

6 Setting up the Printer through Toolbox

6.1 Setting up the Printer through Toolbox (PC Software)

In Preparation

6.2 Firmware Download

The controller has an option to update firmware and/or font, and batch files through the USB or RS232 interface.

In RS232 mode, the update can only be carried out through the transfer setting 115200, n, 8, 1.

All control commands required for the download are already integrated in an update file, which only has to be sent to the controller. The controller will load the file and automatically save it in its program memory (flash).

After the successful transfer and programming process, the printer will automatically restart.

Should an error occur during the download process, the controller will remain in download mode and wait for a new download process to start.

If valid firmware is available when the controller voltage is connected, the boot loader of the controller will first check, whether paper is inserted. If this is the case, the printer software will be started immediately. If no paper is inserted, the boot loader will wait for an update for about 5 seconds. Once update data are recognized, the bootload process is started, or the printer firmware is started after 5 seconds.

The baud rate of the printer is now set to the value specified by the printer parameters. Font or firmware update files for downloading are available on the Internet or on request.

Using the Boot Loader in the Field:

- * Connect printer to serial interface of PC.
- * Set RS232 of PC to 115.2 Kbaud.
- * Remove paper roll from the printer (programming recognition for the boot loader).
- * Reset printer.
- * Within 5 seconds, send boot file from PC to printer.
- * Boot update will take about 3 - 5 seconds.

A restart will follow after the end of the program update. The printer will automatically perform a reset. After that, the printer can be used normally. The baud rate of the printer is now set to the value specified by the printer parameters.

7 Interfaces

7.1 Serial Interface

RS232 Interface

The included interface cable connects directly to an RS232 connection (COM interface of a PC). A cable with five individual wires that are open ended on one end is available as an option.

TTL Interface

For OEM, a special version with 3.3V TTL levels can be realized on request.

7.1.1 Serial Interface RS232 (V.24) at Connector J2

Connector at the printer: JSTSH (5pin).

Cable: GKA-406: The opposite end has a 9pin SUB-D socket.

The assignment is a 1:1 match with the serial interface of the PC. Please note that with some interfaces, the DSR and DCD have to be terminated.

PIN Assignment

| Pin | Signal | In-put/ Out-put | Comment | Assignment Cable GKA-406 D-SUB 9Pin |
|-------------------------|--------------------|--------------------|--|--|
| 1 | GND signal | GND | | 5 |
| 2 | TXD | I | Print data | 3 |
| 3 | RXD | O | Error messages and Xon/Xoff messages | 2 |
| 4 select- able *) | RTS | I | Handshake input of the controller (Standard: wake-up function) | 7 |
| | +4.5V digital | O | Supply for external adapters | |
| | +4.5V - 7.2V power | O | Supply for external adapters | |
| 5 | CTS | O | If the level is logic-true, the controller can receive data. | 8 |

*) Selectable through resistors. Please contact us with your inquiry.

1,4,6,9 = NC

7.1.2 Timing of the Serial RS232 /TTL Interface

The default timing is shown in the diagram below.

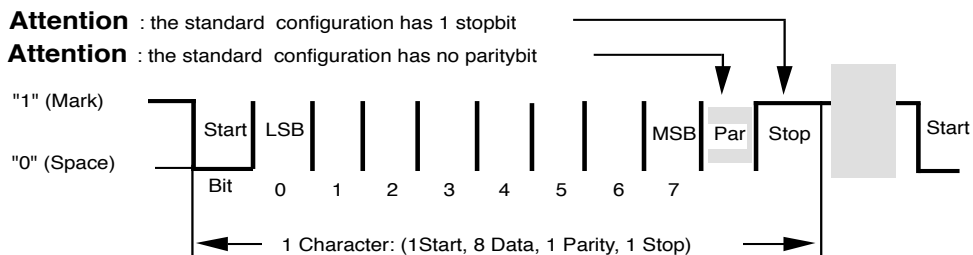

| Signal | Level on TTL interface | Level on RS-232 interface |
|-------------|------------------------|---------------------------|
| "1" (Mark) | +5V (TTL-level) | -3V ... -12V |
| "0" (Space) | 0V (TTL-level) | +3V ... +12V |

Serial Data Format Standard:

- 115200 baud
- 8 data bits
- non-parity bit
- 1 stop bit

Selectable Data Formats

- 1,200; 2,400; 4,800; 9,600; 19,200; 38,400; 57,600; 115,200; 230,400 and 460,800 baud
- 7/8 data bits
- odd, even, non-parity bit
- 1, 2 stop bit

7.2 USB Interface

USB Printer Class

The USB device class is "Printer Class".

When plugged in, the PC will report "USB printer support" and install a "USB001"USB port.

Either the standard printer driver of the "system78" or the port monitor can be used. During installation of the printer driver, it can be easily guided to the USB port.



Attention

Windows®XP and Windows®CE handle the numeration of a printer differently. Therefore, the printer must be configured to the operating system before delivery.

8 Operation

8.1 Button functions

The buttons have different functions depending on the status – normal operation or print settings menu. The time for which the buttons are held down also determines functionality.

FEED / ENTER (1)

This button wakes up the printer from the sleep mode and transports the paper forward.

When the feed button is pressed, the printer will first feed one line of the set font. If the button is held down for more than two seconds, it will feed continuously.

Self Test

By starting a self test printout, the printer functions can be tested. For this purpose, either a software reset command has to be sent to the printer or the FEED button (1) has to be held down when reactivate the printer from power-OFF. The printer performs a self test. The interfaces are not tested at this time.

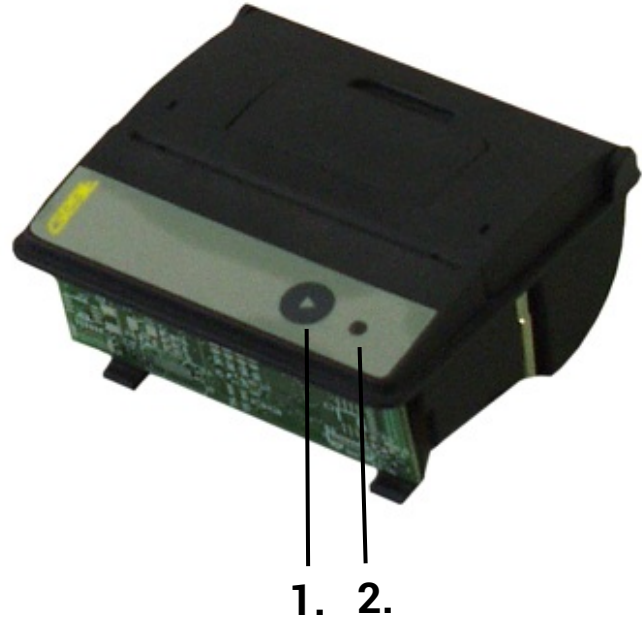

8.2 Thermal Paper

The printer is specified for a paper width of 57.5 ± 0.5 mm, 60 g/m² paper thickness. GeBE is offering suitable paper rolls. Use $57.5 \text{ mm} \pm 0.5 \text{ mm}$ wide paper with outside coating, with a roll diameter of 31 mm for the GPT4352 and 60 mm for the GPT4352-60.

Standard GPT4352: GPR-T01-058-031-007-060A

Standard GPT4352-60: GPR-T01-058-060-007-060A

Other papers may cause failures.

Thermal papers that are resistant against water, grease, or alcohol are available for special applications. We will gladly assist you in selecting the right thermal paper for your purposes.



Which side of the thermal paper can be printed on?

Usually, the printable side is the one on the outside of the paper roll. When in doubt, try the finger nail test: Quickly run the tip of a finger nail across the paper, applying pressure. The friction heat will cause blackening on the thermo-sensitive side.

How do I insert the paper?

1. Unwind about 10 cm of paper from the roll. Keep the layers wound tightly.
2. Open the printer lid by pressing the LEVER inside the lid slightly upwards. The print roll is lifted from the printer mechanism together with the lid. The lid is now easily opened up.
3. Insert the paper roll in the paper compartment, so the outside shows toward the printer mechanism. Only this outside can be printed on.
4. Close the lid applying strong pressure. You will hear it snap in, and you will now be able to tear the paper at the tear-off edge without the lid reopening or the paper sliding through the print head.

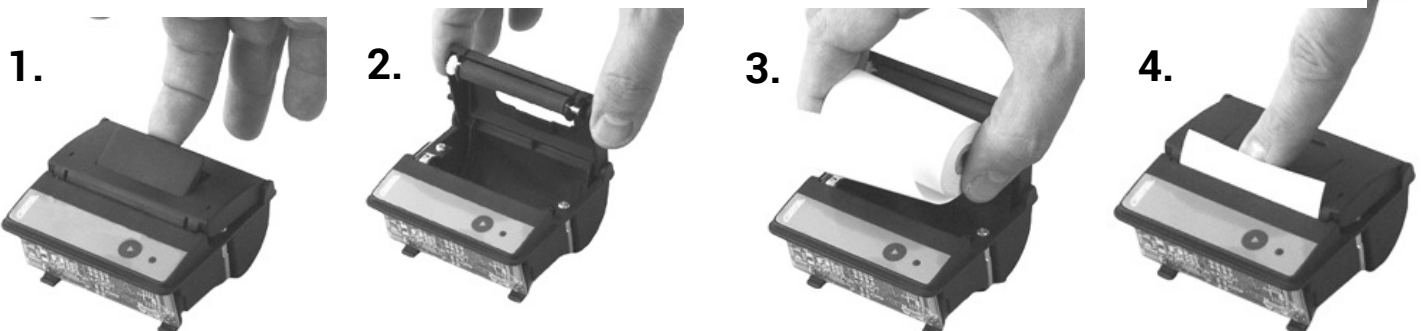

9 Maintenance and Service

9.1 Cleaning

After larger print jobs, depending on the paper quality and adverse environmental conditions, it may be necessary to clean print head, sensor and platen roll, especially, if some areas are no longer printed properly.

- Open the paper supply lid and remove the paper roll.
- Loosen dirt particles at paper, sensor, and tear bar with a small brush.
- Blow forcefully into the paper supply compartment in order to remove coarse dust.
- Soak cotton swab with isopropanol (IPA) and clean the print head, or use print head cleaning pen / cleaning card.
- Other stubborn debris may also be removed with a cotton swab (IPA).



Never use sharp objects for cleaning. This may damage the print head.

9.2 Service



Service

For service or questions, please contact: GeBE Elektronik und Feinwerktechnik GmbH
Beethovenstr. 15 • 82110 Germering • Germany • www.gebe.net
Phone:++49 (0) 89/894141-0 • Fax:++49 (0) 89/8402168 • e-mail: sales.ef@gebe.net



Further information

Further information is available at www.oem-printer.com/piano.

At this address, you can also find a personal consultant you can turn to with your questions.

Or, contact the GeBE sales team via email: sales.ef@gebe.net

For orders you can use this fax number: +49 (0) 89/894141-33

9.3 Warranty

We guarantee that all goods supplied by GeBE possess the warranted features. The guarantee period for OEMs is 12 months unless other terms have been agreed upon in writing. The guarantee period is calculated from the date of shipment.

The warranty is null and void, if the customer fails to claim an occurring defect without delay and in writing.

Detailed information on our warranty is part of our terms of delivery and payment, which can be seen and downloaded at www.oem-printer.com/lzb (home page chapter: About Us).

11 Status Signals

LED "STATUS" (green) (2)

The STATUS-LED glows permanently green, when everything is okay. It flashes to signal a failure.

Status Signals of the Printer through the Interfaces

In addition to the optical status signals through the LEDs on the control panel of the printer, some signals are sent through the serial interface. Most are individual ASCII characters that are evaluated by the host computer.

Whenever an error occurs, the status LED will flash 1:1

To avoid that old unfinished print orders immediately start printing after completion of the Easyload mechanism, causing a paper jam, there is a built-in error lag of about 2 seconds. Should errors occur, the printer mechanism will be blocked for two seconds after the last error has been cleared. This gives the user enough time to close the lid without having the printer start immediately.

The bits are defined as follows:

1. status byte

| Bit | LED | Status | 0 | 1 |
|-----|-----|-----------------------|----------------|------------------------|
| 0 | on | near paper end (NPE) | low paper | paper ok |
| 1 | 1:1 | paper sensor | no paper | paper present |
| 2 | 1:1 | temperature | temperature ok | printhead too hot/cold |
| 3 | 1:1 | printhead | closed | open |
| 4 | 1:1 | paper jam/cutter | no error | error |
| 5 | on | Rx error | no error | Rx error |
| 6 | | always 0 (identifier) | | |
| 7 | | always 1 (identifier) | | |

12 Troubleshooting and Recovery

Not every failure means that there is an error with the printer.
You will save time and money by recognizing and fixing simple errors on your own.
The following tips are meant to help you with this:

| Symptom | Possible Cause | Remedy |
|---|---|---|
| Power Supply | | |
| The printer seems to be printing. Paper is transported, but not blackened. | Paper: Wrong side facing the print head. Only one side of the paper can be printed on. | Insert paper correctly. The thermosensitive side should be turned to the outside of the roll (most of the time). Try the finger nail test: Drag the tip of a finger nail across the paper, pressing down. The friction heat causes the thermosensitive side to blacken. |
| At the beginning of printing, the LED goes out just briefly. | The power supply is not optimal. | Use short feed lines with sufficient thickness. Check all connections for possible transfer resistances. Since high peak currents occur with thermal printers, even the smallest transfer resistances can result in intolerable voltage drops. In this case, no power supply would be strong enough. |
| The printer only prints a few dots in one line. | Cross section of feed line is too weak. | |
| The paper feed works, but the self test does not. | Supplied power too low. | |
| The printer only prints a few characters in one line. If more is entered, it stops printing altogether. | | |
| Serial Interface | | |
| After a few characters, the printout starts to be incomplete. | The printer buffer is "over-run" (256 bytes), causing a loss of data. The print data transmitter shows no reaction to handshake. | Use or check handshake. (software: Xon/Xoff or hardware: CTS). If necessary, slow down transmission speed, e.g. down to 1,200 baud. |
| The printer prints the wrong characters. | Interface problem. The transmission is faulty. (Characters of the upper area are printed). | Use correct interface level. (RS232, TTL?). The transmission cable may be too long. |
| | Wrong data format is set. | Set the correct baud rate in the parameter settings. Check data format. |
| | Bad ground connection that causes a part of the printing current through the interface cable. This leads to an increase in potential there, which results in data corruption. | Check and improve ground connection. Feed current through short, thick lines. |

13 CE Certification

The failure-free operation of the printer (assessment criterion A) is achieved, when all printed information remains recognizable in case of a short-term failure, and the printer, on the other hand, automatically returns to its normal functional status afterwards.

DECLARATION OF COMFORMITY

in compliance with EN45014

KONFORMITÄTSERKLÄRUNG

in Übereinstimmung mit EN45014

Supplier: **GeBE Elektronik und Feinwerktechnik GmbH**
 Anbieter:

Address: **Beethovenstr.15**
 Anschrift: **82110 Germering**
Germany

Products: begining with Serial Number: **1001xxxx**
 Produkte: beginnend mit Seriennummer: **1001xxxx**

- GPT-4352-60-LV-93-24-USB-DC24**
- GPT-4352-60-LV-93-24-V.24-DC24**
- GPT-4352-60-LV-93-24-TTL-DC24**
- GPT-4352-LV-93-24-USB-DC24-S59**

The Products described above are in conformity with:
Die oben beschriebenen Produkte sind konform mit:

- EMC Directive / EMV Richtlinie89/336/EWG**
- Information technology equipment
- Einrichtungen der Informationstechnik
- Radio disturbance characteristicsEN 55022 1998
- Funkstöreigenschaften
- Immunity characteristics.....EN 55024 2003
- Störfestigkeitseigenschaften

Germering, the 5/3/2010, den 03.05.2010

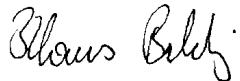

Klaus Baldig
 Head of R&D/ Leiter der Entwicklung

GeBE Elektr onik und Feinwer ktechnik GmbH GKV 027- 1

| Component | CE | in particular |
|-----------|----|---|
| Printer | CE | See conformity statement - available on request |
| | | |

14 Technical Data

| | GPT-4352-...-V.24 | GPT-4352-...USB |
|------------------------------|--|--|
| Print procedure | Fixed thermal print line | |
| Paper / print width | 57.5 ± 0.5 mm / 48 mm | |
| Resolution | 8 dots/mm, 384 dots/line | |
| print speed | up to 50 mm/s | |
| Supply voltage | 4.5 - 7.2 VDC or 10 - 36 VDC | |
| Power consumption | Online: typ. 30 mA | |
| Max. current during printing | Adjustable by command to max. 0.7 A - 6 A, depending on operating voltage | |
| Interfaces | RS232 to 460 kbps (optimal TTL) Baud rates: 1,200; 2,400; 4,800; 9,600; 19,200; 38,400; 57,600; 115,200 ; 230,400; 460,800 Mode: adjustable: 7, 8 data bit, 1,2 stop bits, none, odd, even parity handshake: hardware handshake and XON / XOFF | USB full speed printer class bidirectional |
| Data compression | Factor app. 3:1 (for graphic commands); PC-compatible; Windows® driver | |
| Character sets, cpl | 24, 48 selectable by control command | |
| Bar code | Code 39 / 2aus5 interleaved / EAN13 optional: UPC-A / PDF417 / Code 128c | |
| Environment | 0 °C to 50 °C (-10 °C to +60 °C using GeBE HQ paper) 10% to 80% rel. humidity, no moisture condensation | |
| MTBF | 50 km printed paper (with specified thermal paper) | |
| Dimensions in mm | GPT-4352: 76.8 x 77.4x 39.3 mm, ET: 27 mm / GPT-4352-60: 76.8 x 111.4 x 72.0 mm, ET: 58.2 mm | |
| Roll diameter | GPT-4352: max. 31 mm / app. 11 m with 60 g/m ² GPT-4352-60: max. 60 mm / app. 40 m with 60 g/m ² | |
| Weight | GPT-4352: app. 150 g incl. paper roll / GPT-4352-60: app. 260 g incl. paper roll | |
| Housing material | GPT-4352: ABS (various colors available) GPT-4352-60: PA66 - GF15 | |
| Norms | CE : See conformity statement | |

15 Mechanical Dimensions

